

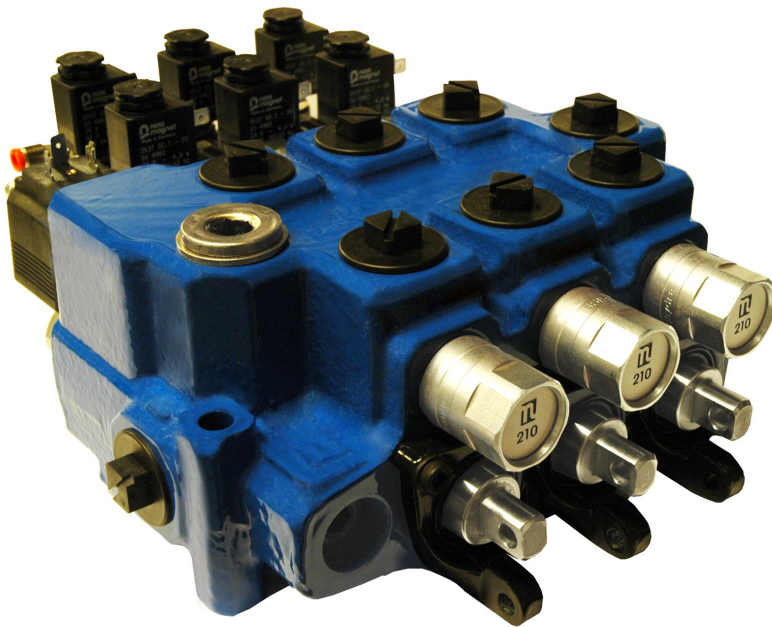

Nordhydraulic
HYDAC INTERNATIONAL

Spare part list RM 270
Part No 1602-006311



Nordhydraulic AB

P.O Box 189

(Industrivägen 15)

SE-872 24 Kramfors

Sweden

Telephone: Int. +46 612 71 72 00

Telefax: Int. +46 612 71 72 15

E-mail: info@nordhydraulic.se

Web: www.nordhydraulic.se



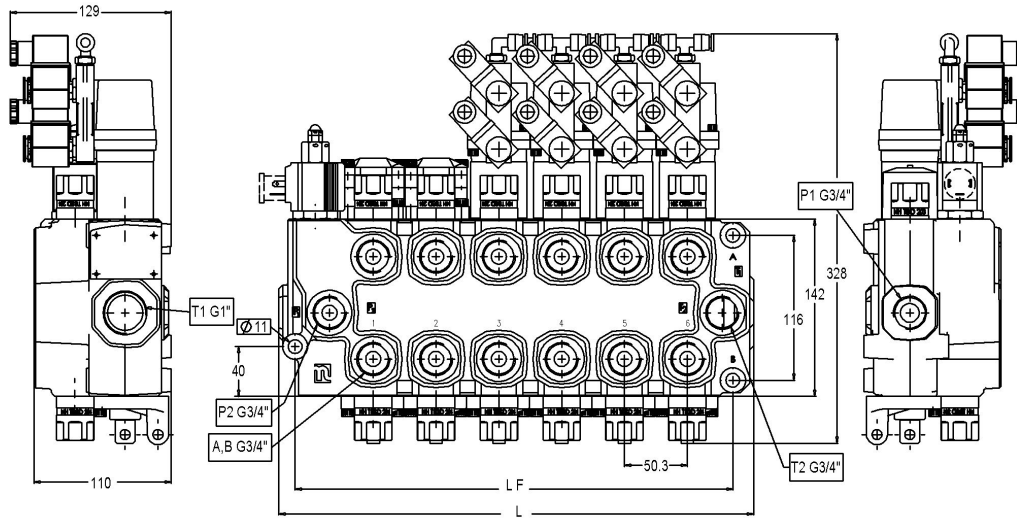

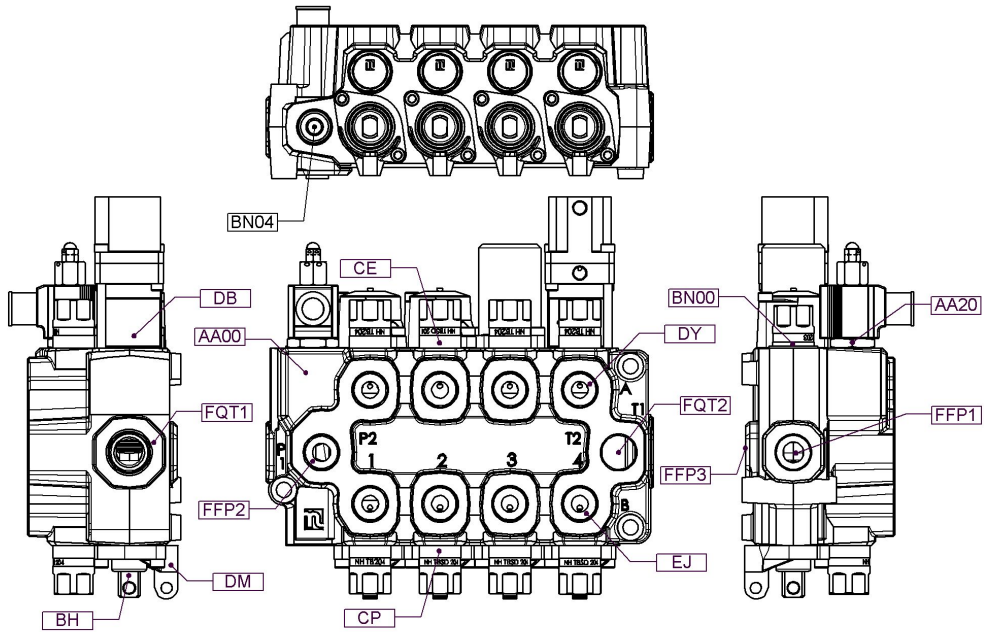

 Spare part list	Valve type RM 270	Coordinat AA20
	Created 2019-03-26	

PE50

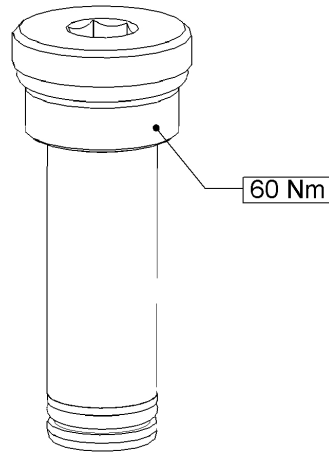

Part No
2310-6919227

Description
Plug, fits the same cavity as IS12, IS24 and IL24

Notes:



Spare part list

Valve type RM 270

Coordinat BH

Created 2019-03-26

107AA1

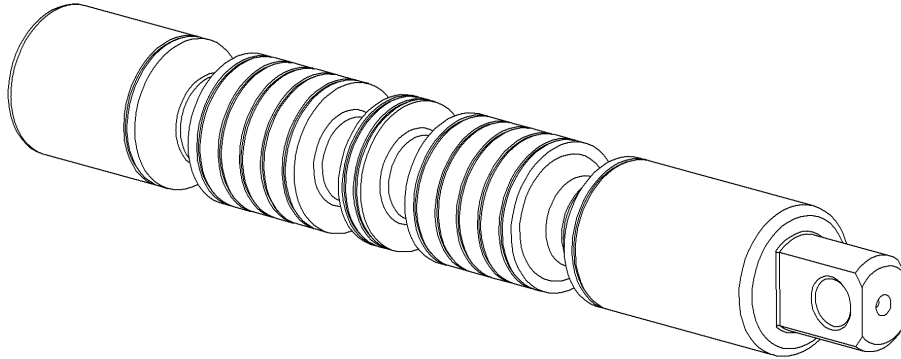

Part No

2125-3905331

Description

Spool, double acting, 50-90 l/min

Notes:



Spare part list

Valve type RM 270

Coordinat BN00

Created 2019-03-26

TBD200

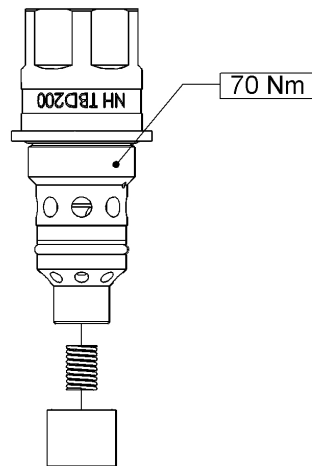

Part No

2275-210672

Description

Main relief valve with sealing washer

Notes:



Spare part list

Valve type RM 270

Coordinat BN04

Created 2019-03-26

MB01

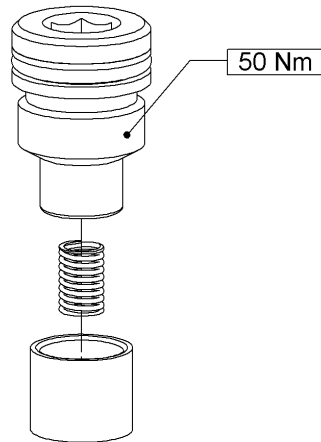

Part No
2250-220017

Description
Check valve

Notes:

 Spare part list	Valve type RM 270	Coordinat CE
	Created 2019-03-26	

P204

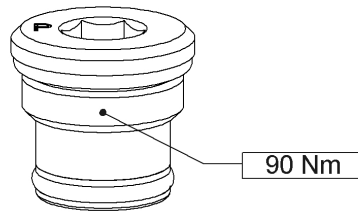

Part No
2310-3900371

Description
Plug

Notes:



Spare part list

Valve type RM 270

Coordinat DB

Created 2019-03-26

PMK2

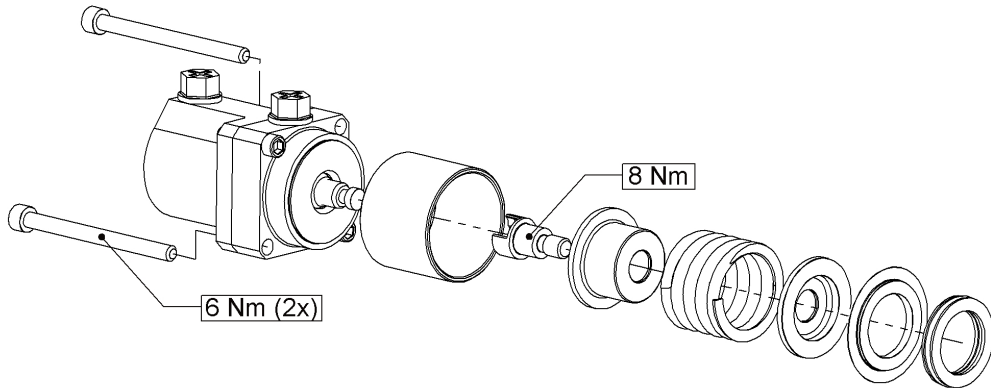

Part No

2175-804292

Description

Spool control 3pos, for pneumatic control.

Notes:



Spare part list

Valve type RM 270

Coordinat DM

Created 2019-03-26

M19

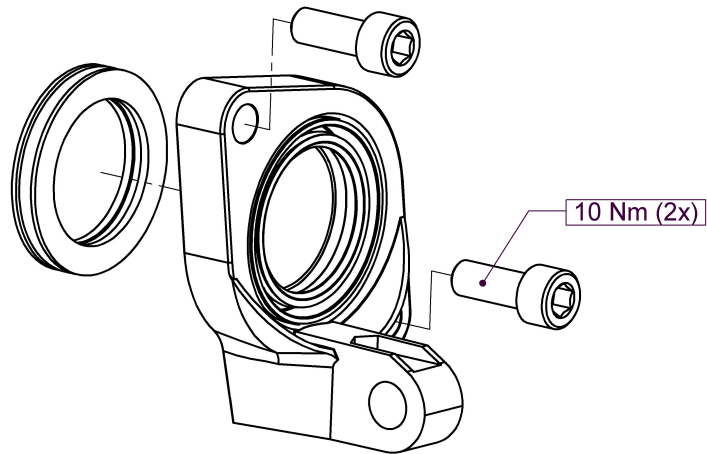

Part No

2200-269632

Description

Bracket for 3 pos spool

Notes:

 Spare part list	Valve type RM 270	Coordinat FF
	Created 2019-03-26	

PG06

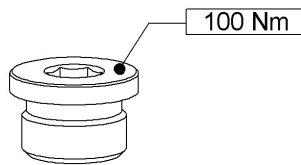

Part No

2310-450100

Description

Plug G 3/4", with O-ring seal

Notes:

