

DIRECTIONAL CONTROL VALVES CETOP 5

1

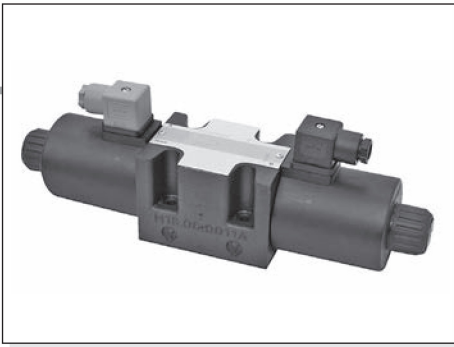

CETOP 5/NG10

STANDARD SPOOLS	CAP. I • 35
AD5E...	CAP. I • 36
AD5E...J*	CAP. I • 37
AD5E...Q5	CAP. I • 37
AD5O...	CAP. I • 38
AD5D...	CAP. I • 38
AD5L...	CAP. I • 39
"A16" DC SOLENOIDS	CAP. I • 40
"K16" AC SOLENOIDS	CAP. I • 40
STANDARD CONNECTORS	CAP. I • 20

INTRODUCTION

The directional control valves NG10 designed for subplate mounting with an interface in accordance with UNI ISO 4401 - 05 - 04 - 0 - 94 standard (ex CETOP R 35 H 4.2-4-05), and can be used in all fields on account of their excellent capacity and pressure specifications.

The use of solenoids with wet armatures means that the construction is extremely functional and safe completely dispensing with need for dynamic seals. The solenoid dust cover is screwed directly onto the valve casing whilst the coil is kept in position by a ring nut.

Great care has been taken in the design and the production of the ducts and the improvement of the spools has allowed relatively high flow rates to be accommodated with minimal pressure drops (Δp). The operation of the directional valves can be electrical, pneumatic, oleodynamic, mechanical or lever operated .

The centring position is achieved by means of calibrated length springs which, once the action of impulse is over, return the spool to the centre or end travel position.

The solenoids constructed with protection class in accordance with DIN 40050 standards are available in either direct current (IP65) or alternating current (IP66) with different voltage and frequencies.

All types of electrical controls can be fitted, on request, with different types of manual emergency controls. The electrical supply takes place through connectors meeting DIN 43650 ISO 4400 standards; connectors are also available with built in rectifier or pilot lights.

The valves are designed for use with DIN 51524 standard hydraulic mineral oils and it is recommended that filters should be fitted to ensure a maximum contamination level of class 10 in accordance with NAS 1638, $\beta_{25} \geq 75$.

PRESSURE DROPS

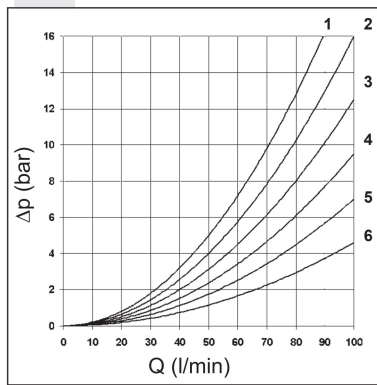

The diagram at the side show the pressure drop curves for spools during normal usage. The fluid used is a mineral oil with a viscosity of 46 mm²/s at 40°C; the tests have been carried out at a fluid temperature of 40°C.

For higher flow rates than those in the diagram, the losses will be those expressed by the following formula:

$$\Delta p1 = \Delta p \times (Q1/Q)^2$$

where Δp will be the value for the losses for a specific flow rate Q which can be obtained from the diagram, $\Delta p1$ will be the value of the losses for the flow rate Q1 that is used.

Spool type	Connections				
	P→A	P→B	A→T	B→T	P→T
01	2	2	5	5	
02	3	3	6	6	3
03	2	2	6	6	
04	3	3	4	4	1
05	3	3	5	5	
06	2	2	5	5	
66	2	2	5	5	
07		1	5	5	
10	3	3	5	5	
11	4			5	
	Curve No.				

Spool type	Connections				
	P→A	P→B	A→T	B→T	P→T
22		4	5		
14	3	3	6	6	2
15	2	2	4	5	
16	2	2	4	5	
17	3	3			
19	3	3	4	5	
20	3	3	4	5	
21	3	3			
28	3	3	6	6	2
	Curve No.				

DIRECTIONAL CONTROL VALVES CETOP 5

1

ORDERING CODE

AD	Directional valve
5	CETOP 5/NG10
*	Type of operator (tab.1)
**	Spools (see tables Cap. I • 35)
*	Mounting type (tab. 2)
*	Voltage / Specification (tab. 3)
**	Variants (tab. 4)
2	Serial No.

TAB.1 - TYPE OF OPERATOR

E	Electrical
D	Direct mechanical
O	Oleo-pneumatic
L	Lever

TAB.2 - MOUNTING

STANDARD	
C	
D	
E	
F	
SPECIALS (WITH PRICE INCREASING)	
G	
H	
I	
L	
M	

- **Mounting type D** is only for valves with detent
- In case of **mounting D** with detent a maximum supply time of 2 sec is needed (only for AC coils).
- The springs for the version with detent (mounting **D**) are different from those for standard versions.

TAB.3 - VOLTAGE / SPECIFICATION

Operator	Voltage Specs.	Description	Note
E	A	24V/50Hz	AC Voltage ** (Technical data see page I • 40)
	B	48V/50Hz*	
	J	115V/50Hz - 120V/60Hz	
	Y	230V/50Hz - 240V/60Hz	
	E	240V/50Hz*	
	F	24V/60Hz*	
	K	Without AC coils	DC Voltage ** (Technical data see page I • 40)
	L	12V	
	M	24V	
	N	48V*	
	P	110V*	
	Z	102V* 115Vac/50Hz 120Vac/60Hz with rectifier	
	X	205V* 230Vac/50Hz 240Vac/60Hz with rectifier	
W	Without DC coils		
D	Z	standard	—
O	Z	standard	—
L	Z	valve with lever	—
	X	valve without lever	—

* Special voltage

** Voltage codes are not stamped on the plate, their are readable on the coils.

TAB.4 - VARIANTS











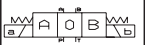
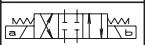







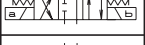
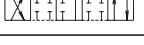
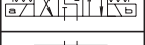
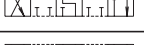
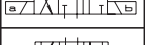
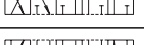

VARIANT	CODE	◆	PAGE
No variant (without connectors)	S1(*)		
Viton	SV(*)		
Emergency button	ES(*)		Cap. I • 40
Preset for microswitch - (E/F/G/H only) see below note ◇	M1(*)	◆	Cap. I • 36 - Cap. I • 39
Rotary emergency button	P2(*)		Cap. I • 40
Marine version (AD.5.O..)	H1	◆	
Spool movement speed control (VDC only) with ø 0.5 mm diameter orifice	5S(*)	◆	Cap. I • 37
Spool movement speed control (VDC only) with ø 0.6 mm diameter orifice	6S(*)	◆	Cap. I • 37
Spool movement speed control (VDC only) with ø 0.7 mm diameter orifice	7S(*)	◆	Cap. I • 37
Spool movement speed control (VDC only) with ø 0.8 mm diameter orifice	8S(*)	◆	Cap. I • 37
External draining solenoid (electrically operated only)	S5(*)	◆	Cap. I • 37
Microswitch+ Detent (for lever operation)	MD	◆	
Detent for lever control	D1	◆	

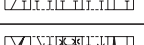
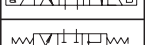
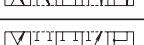
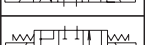
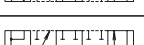
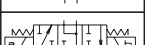
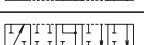
◇ = Maximum counter-pressure on T port: 4 bar - Microswitch type MK code 1319098 must be ordered separately.
◆ = Variant codes stamped on the plate

(*) Coils with Hirschmann connection supplied without connectors. The connectors can be ordered separately, Cap. I • 20.

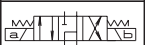









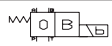







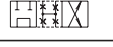



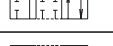

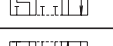

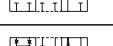
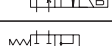
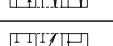
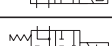
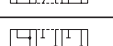
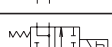





DIRECTIONAL CONTROL VALVES CETOP 5











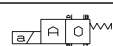

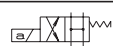







1

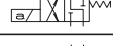

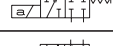
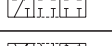
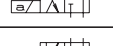
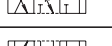
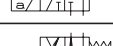
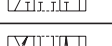
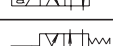
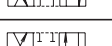
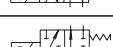
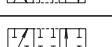

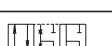

TWO SOLENOIDS, SPRING CENTRED "C" MOUNTING			
Spool type		Covering	Transient position
01		+	
02		-	
03		+	
04*		-	
05		+	
66		+	
06		+	
07*		+	
08*		+	
10*		+	
22*		+	
11*		+	
12*		+	
13*		+	
14*		-	
28*		-	

ATTENTION

- (*) Spool with price increasing
- With spools 15 / 16 / 17 only the mounting E / F are possible
- 19 / 20 / 21 spool not planned for AD5E...J*
- For lever operated the spools used are different. Available spools for this kind of valve see AD5L...

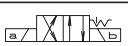
ONE SOLENOID, SIDE B "F" MOUNTING			
Spool type		Covering	Transient position
01		+	
02		-	
03		+	
04*		-	
05		+	
66		+	
06		+	
08*		+	
10*		+	
22*		+	
12*		+	
13*		+	
07*		+	
15		-	
16		+	
17		+	
14*		-	
28*		-	

ONE SOLENOID, SIDE A "E" MOUNTING			
Spool type		Covering	Transient position
01		+	
02		-	
03		+	
04*		-	
05		+	
66		+	
06		+	
08*		+	
10*		+	
12*		+	
15		-	
16		+	
17		+	
14*		-	
28*		-	

TWO SOLENOIDS "D" MOUNTING			
Spool type		Covering	Transient position
19*		-	
20*		+	
21*		+	

AD5E... SOLENOID OPERATED VALVES CETOP 5

1

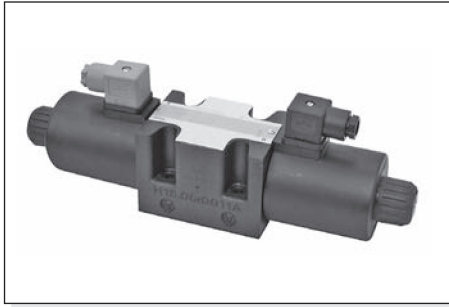

A max. counter-pressure of 4 bar at T is permitted for the variant with a microswitch (MS).

Max. pressure ports P/A/B	350 bar
Max. pressure port T (DC coil) see note (*)	250 bar
Max. pressure port T (AC coil)	160 bar
Max. flow	100 l/min
Max. excitation frequency	3 Hz
Duty cycle	100% ED
Fluid viscosity	10 ÷ 500 mm ² /s
Fluid temperature	-25°C ÷ 75°C
Ambient temperature	-25°C ÷ 60°C
Max. contamination level	class 10 in accordance with NAS 1638 with filter $\beta_{25} \geq 75$
Weight (with one DC solenoid)	4 Kg
Weight (with two DC solenoids)	5,1 Kg
Weight (with one AC solenoid)	3,5 Kg
Weight (with two AC solenoids)	4,3 Kg

(*) Pressure dynamic allowed for 1 million of cycles.

OVERALL DIMENSIONS

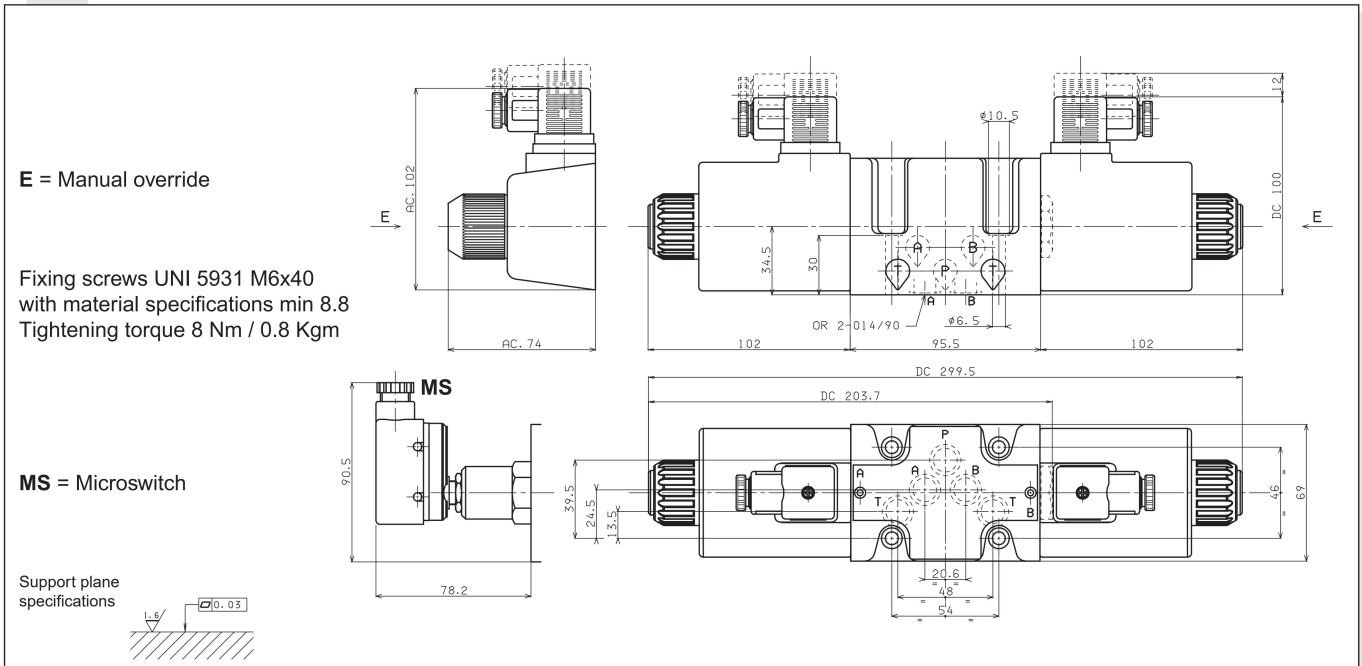

LIMITS OF USE (MOUNTING C-E-F)

The tests have been carried out with solenoids at operating temperature and a voltage 10% less than rated voltage with a fluid temperature of 40°C. The fluid used was a mineral oil with a viscosity of 46 mm²/s at 40°C.

The values in the diagram refer to tests carried out with the oil flow in two directions simultaneously T = 2 bar (e.g. from P to A and the same time B to P).

In the cases where valves 4/2 and 4/3 were used with the flow in one direction only, the limits of use could have variations which may even be negative. Rest time: the values are indicative and depend on the following parameters: hydraulic circuit, fluid used and variations in hydraulic scales (pressure P, flow Q, temperature T).

Direct current	Energizing	60 ÷ 95 ms.	Alternating current:	Energizing	12 ÷ 30 ms.
	De-energizing	25 ÷ 70 ms.		De-energizing	10 ÷ 55 ms.

NOTE: The operating limits shown are valid for mountings C, E, F.

DIRECT CURRENT SOLENOIDS (DC)

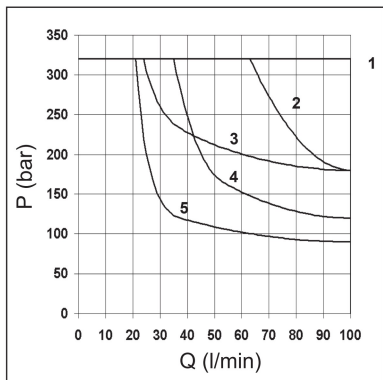

Spool type	DC	AC
	01	1
02	1	6
03	2	7
04	4	10
05	1	6
06 - 66	3	9
14-28	5	11
15	3	10
16	1	6
Curves		

ALTERNATING CURRENT SOLENOIDS (AC)

