

Solenoid operated valves pilot operated poppet type  
2-way normally closed  
Common cavity, Size 10

VEI-16-10A-NC

OD.15 - X - 36 - Y - Z

**RE 18323-32**

Edition: 12.2022

Replaces: 04.2021

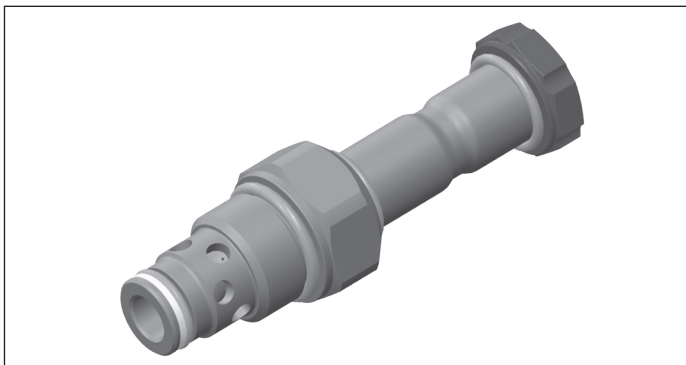

**PATENT PENDING**

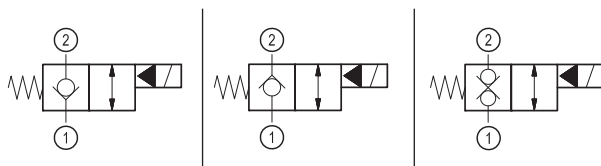
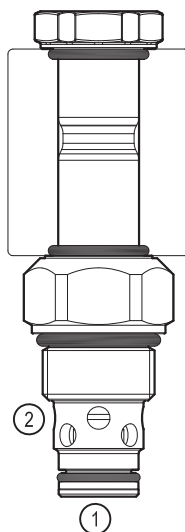

**Technical data**

New VEI-16 family incorporates a new solenoid concept providing excellent performance and enables cartridges to work in severe environment. Cartridges also incorporates advanced design of hydraulic parts providing excellent hydraulic performance.

**Technical data**

General	
Weight	0.25 kg (0.55 lbs)
Installation orientation	Unrestricted
Storage ambient temperature range	-40 to 100 °C (-40 to 212 °F)
Operating ambient temperature range	-30 to 90 °C (-22 to 194 °F)
Hydraulic	
Max. operating pressure	350 bar (5000 psi)
Flow range	2 - 70 l/min (0.53 - 18 gpm)
Fatigue cycle life	2 million cycles at 350 bar
Max. internal leakage	5 drops/min. for X=05 20 drops/min. for X=03,31
Switching time	Opening ≤ 50 ms Closing ≤ 100 ms
Fluid temperature range	-20 to 80 °C (-4 to 176 °F)
Fluids: Mineral-based or synthetics with lubricating properties at viscosities of 20 to 380 mm <sup>2</sup> /s (cSt)	
Installation torque	44 - 56 Nm (33 - 41 ft-lbs)
Recommended degree of fluid contamination	Nominal value max. 10 µm (NAS 8) ISO 4406 19/17/14
MTTFd	150 years see RE 18350-51
Cavity	CA-10A-2N see 18325-70
Seal kit for X=05	code RG10A2010520100 material no. R901111363
Seal kit for X=03, 31	code RG10A2010530100 material no. R901111366
Seal kit coil and standard cap	code RG02Z0010000100 material no. R930067869
Seal kit coil and protective cap only for Y=D	code RG03Z0010000100 material no. R930067870
Other technical data	See data sheet 18350-50
Electrical	
Type of voltage	DC voltage
Coil type	D36
Supply voltage	See data sheet 18325-90
Voltage tolerance against ambient temperature	See characteristic curve
Power consumption	20 W
Type of protection	See data sheet 18325-90
Note: Coils must be ordered separately	

**Ordering code**

<b>OD.15</b>	<b>X</b>	<b>36</b>	<b>Y</b>	<b>Z</b>	<b>0000</b>	<b>*</b>
--------------	----------	-----------	----------	----------	-------------	----------

Solenoid operated valves  
pilot operated poppet type  
2-way normally closed

---

bidirectional type

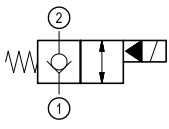

**05**

---

bidirectional type

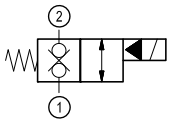

**31**

---

bidirectional type

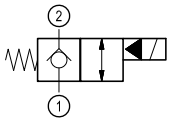

**03**

Series O/A to L  
unchanged performances and dimensions

0 = With buna seal  
8 = With buna seal and extra spring only for **05, 31**  
V = With Viton seal  
P = With buna seal and protective cap for override version **D**  
T = With Viton seal and protective cap for override version **D**

A = Standard  
D = Knob style manual override  
E = Pull style manual override  
F = Hand operated pull style manual override

Common cavity: CA-10A-2N

**Preferred types**

Type	Material number
OD150536A000000	R930063002
OD150536D000000	R930062969
OD150536E000000	R930062947
OD150536F000000	R930062967
OD150536DP00000	R930062946
OD153136A000000	R930065511
OD153136D000000	R930066658
OD150336A000000	R930065691

Type	Material number
OD150536A800000	R930065844
OD153136A800000	R930067585
OD153136D800000	R930068786
OD150336D000000	R930071617

Characteristic curves

All Versions - Admissible supply voltage Vs. Ambient temperature at 100% duty cycle

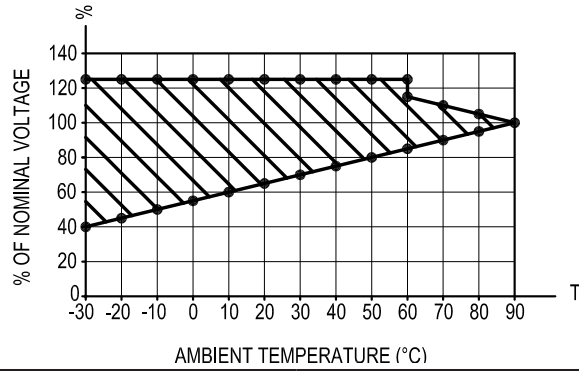

Version 05 Version 05 with extra spring

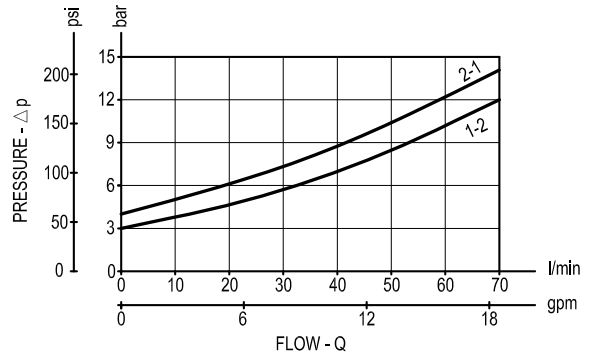
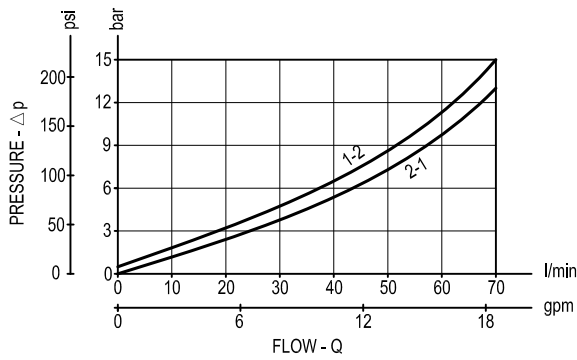

Version 31 Version 31 with extra spring

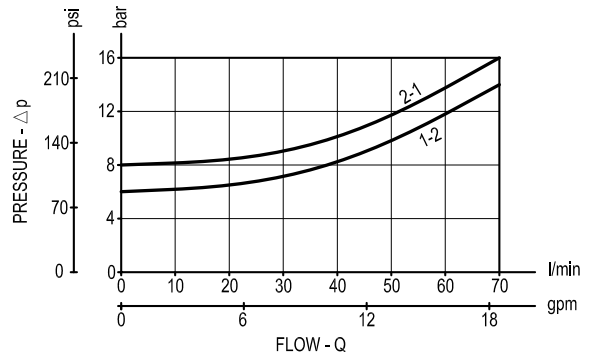
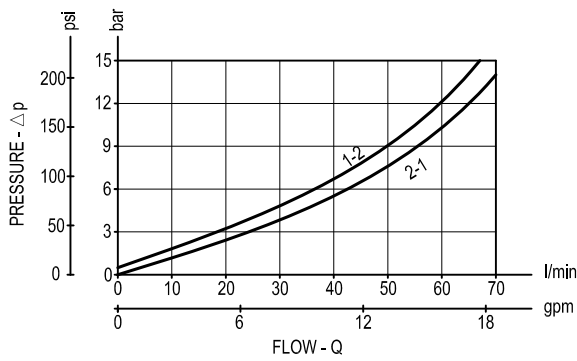

Version 03

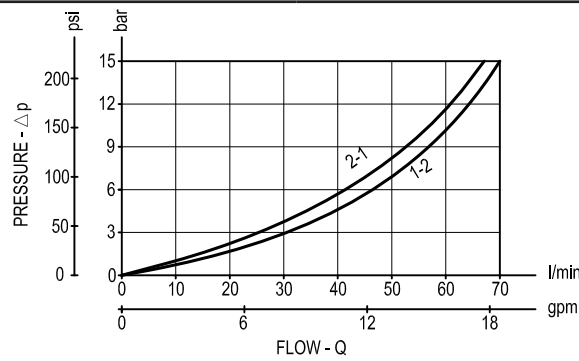

## Dimensions

### Solenoid operated valves, poppet 2-way normally closed

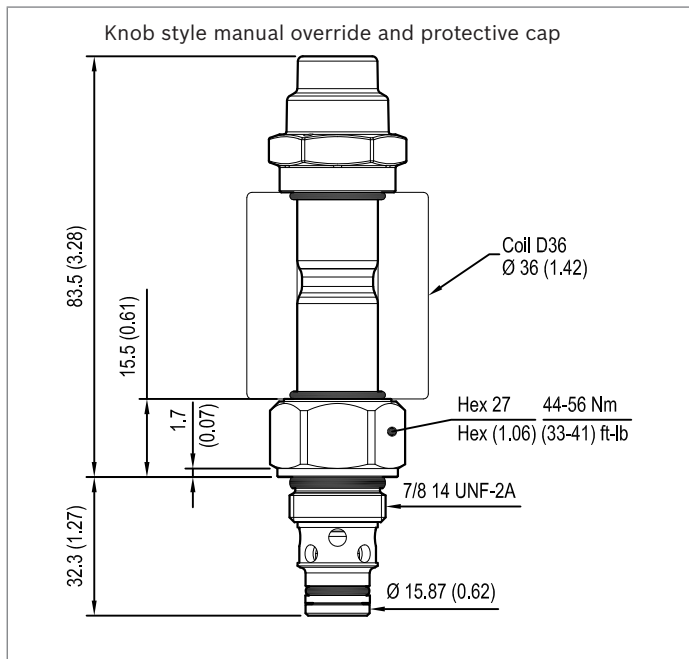
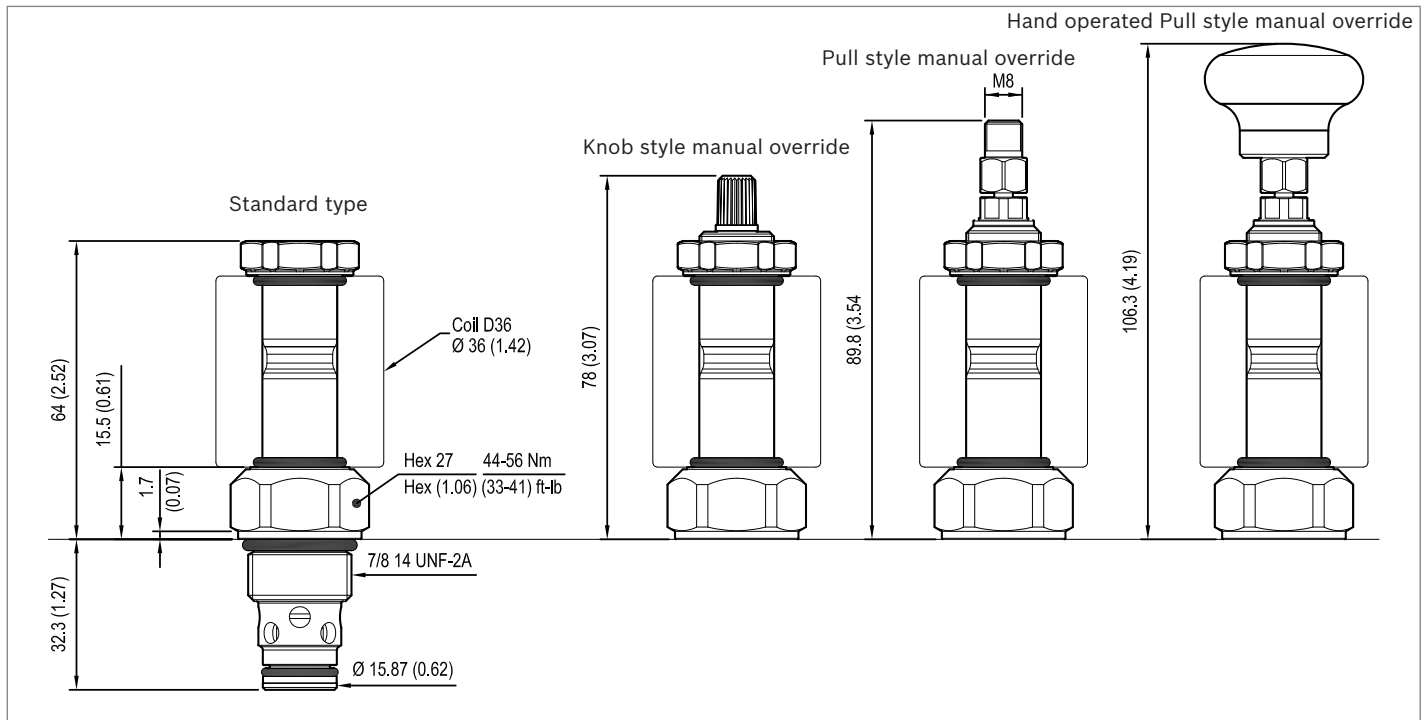

#### Bosch Rexroth Oil Control S.p.A.

Via Leonardo da Vinci 5  
P.O. Box no. 5  
41015 Nonantola – Modena, Italy  
Tel. +39 059 887 611  
Fax +39 059 547 848  
compact-hydraulics-cv@boschrexroth.com  
www.boschrexroth.com/compacthydraulics

© This document, as well as the data, specifications and other information set forth in it, are the exclusive property of Bosch Rexroth Oil Control S.p.a.. It may not be reproduced or given to third parties without its consent. The data specified above only serve to describe the product. No statements concerning a certain condition or suitability for a certain application can be derived from our information. The information given does not release the user from the obligation of own judgment and verification. It must be remembered that our products are subject to a natural process of wear and aging. Subject to change.